

Thinking about new cabinetry?



Think about this.

Steam from a coffeemaker
will ruin some cabinets.

Which ones? Find out. Be informed.

Use the guide inside to discover
the best cabinetry choice for your home.

FIELDSTONE[®]
C A B I N E T R Y

First, make sure your cabinets have a finish that will last.

THE MOST IMPORTANT THING TO KNOW



A very durable finish is an oven-cured catalyzed conversion varnish top coat. It provides a clear, non-yellowing, chemically-resistant finish. The finish is smooth and has a pleasing sheen.



The least durable top coats are lacquer and catalyzed lacquer. Just a few years after lacquer-finished cabinets are installed, the area around the pulls and knobs develop a tacky, dark color. That is the lacquer wearing down from everyday handling and exposure to water (sink), detergents, chemicals, and steam (coffee maker and dishwasher). Lacquers also yellow over time. This does not happen with a catalyzed conversion varnish.

Our people and our process



When wood cabinets are finished correctly, they become a beautiful, stunning element in your home.

All cabinet manufacturers have access to the industry's entire line up of finish materials, from good to better to best. At Fieldstone Cabinetry, we start with only the best material.

Then, we choose processes that make the most of these finish materials

Each finish we offer creates a unique furniture look, adding beauty, color, and depth to nature's most versatile material: wood.

Depending on the color you choose for your Fieldstone Cabinetry, your cabinetry may go through 8, 10 or 14 steps in our factory, so we can lay down the most beautiful, smooth and durable finish possible.

"Baking" a finish is necessary to achieve the most durable finish, so all our finishes require the cabinetry component to go through our industrial oven at least twice.

More important than the number of steps in our finish process are our employees. More than a third of our production employees work in our Finishing Department.

Throughout the entire production process, we have inspectors at every step, including the final step, to ensure quality. All employees are empowered to pull any component off the line if it does not meet their standards.

Ask these questions before you buy.

	FIELDSTONE[®] C A B I N E T R Y	Cabinetry from Shop A	Cabinetry from Shop B
<p>What type of finish is used? A very durable finish is an oven-cured catalyzed conversion varnish top coat. It provides a clear, non-yellowing, chemically-resistant finish. The least durable top coats are lacquer and catalyzed lacquer. Just a few years after lacquer-finished cabinets are installed, the area around the pulls and knobs develop a tacky, dark color. That is the lacquer wearing down from everyday handling and exposure to water (sink), detergents, chemicals, and steam (coffee maker and dishwasher). Lacquers also yellow over time. This does not happen with a catalyzed conversion varnish.</p>	<p>Fieldstone Cabinetry uses a catalyzed conversion varnish. Cabinetry finished with this process will look better and hold up better over time compared to cabinetry with a lacquer top coat.</p> <p>Our finish is more than durable, it's beautiful. Our top coat has a lustrous feel, incredible depth, and an understated, elegant satin sheen. It's what you'd expect of fine heirloom furniture, so we call it the "Furniture Finish."</p> <p>In addition to the sheen of the Furniture Finish, Fieldstone Cabinetry also offers Matte Top Coat on stain-based cabinet colors.</p>	☞	☞
<p>Who supplies the finish materials?</p>	<p>Fieldstone Cabinetry uses finish materials from only the best and most reputable manufacturers. The coatings comply with all regulations regarding Volatile Organic Compounds (VOC) and formaldehyde.</p>	☞	☞
<p>What is the finish process?</p>	<p>Fieldstone Cabinetry has a multi-step finish process that is one of the very best in the industry.</p> <p>Fieldstone Cabinetry finishes cabinetry in a professional, climate controlled system. The varnish is catalyzed and oven cured to provide a super hard finish that is clear, non-yellowing and chemically resistant.</p> <p>Each cabinet in a Fieldstone Cabinetry installation will have a pleasing overall color match due to our exacting color standards and controlled manufacturing environment.</p>	☞	☞
<p>If a door has to be replaced, can you get it finished to match your kitchen? Watch out for cabinetmakers who may not be in business when you need a door or two down the road.</p>	<p>Fieldstone Cabinetry has been in business for over 45 years. Fieldstone will be there if you need a door, a hinge, or a glide.</p>	☞	☞

Second, your cabinets need to be rugged.

- What is the warranty?
- For interiors, avoid uncoated particle board. It absorbs water and bubbles appear, as illustrated below.



















- Some cabinetmakers create cabinet exteriors with a mix of wood and melamine components. Be aware that melamine doesn't age like the wood components will, and eventually your kitchen will be two different colors.

Ask these questions before you buy.

	FIELDSTONE[®] CABINETS	Cabinetry from Shop A	Cabinetry from Shop B
Cabinetry has to endure hard knocks. What is the warranty?	Fieldstone Cabinetry has a limited Lifetime Warranty. Fieldstone Cabinetry has been in business for over 45 years. Fieldstone will be there if you need a door, a hinge, or a glide.	<input type="checkbox"/>	<input type="checkbox"/>
Is the product on view? Avoid cabinet-makers who do not have their product on display. You need to open and close doors and drawers, judge the glides, and judge the material, methods and joinery used to build the cabinets.	Fieldstone Cabinetry is on display.	<input type="checkbox"/>	<input type="checkbox"/>
Do you care where your cabinets are made?	Fieldstone Cabinetry is manufactured in Sioux Falls, South Dakota from domestic and global components.	<input type="checkbox"/>	<input type="checkbox"/>
Do you care if your cabinets are environmentally friendly?	Our employees are trained extensively on the most responsible use of materials, whether that is efficient utilization of chemicals or recycling cardboard.	<input type="checkbox"/>	<input type="checkbox"/>
Do you care if your cabinetmaker is socially responsible?	Fieldstone Cabinetry donates all the cabinetry needed by Habitat for Humanity in South Dakota.	<input type="checkbox"/>	<input type="checkbox"/>

Learn more about quality construction.

FIELDSTONE[®] C A B I N E T R Y		What to watch out for	Cabinetry from Shop A	Cabinetry from Shop B
Face Frames	Solid 3/4" hardwood joined with concealed screws and glue. Rails and stiles are dadoed to receive end panels, tops and bottoms.	How are the face frames attached to the cabinet box? Some cabinetmakers cut costs by just nailing the face frame to the side panels, instead of using durable, time tested woodwork joinery.		
End Panels	3/4" Hardwood Plywood Veneer Core–Unfinished	Particle board isn't very strong, and it doesn't take finish evenly. Some cabinetmakers create cabinet exteriors with a mix of wood and melamine components. Be aware that melamine doesn't age like the wood components will, and eventually your kitchen will be two different colors.		
Options	3/4" Hardwood Plywood Veneer Core–Finished Furniture End			
Options	3/4" Hardwood Plywood Veneer Core–Flush* & Finished			
Options	3/4" Hardwood Plywood Veneer Core–Finished			
Tops	1/2" Hardwood Plywood Veneer Core			
Bottoms	1/2" Hardwood Plywood Veneer Core			
Back Panels	Nominal 1/4" Hardwood Plywood	Some cabinetmakers cut costs by eliminating the back panel. When you open the cabinet door, you will see the wall.		
Options	3/8" Beaded Back			
Options	3/4" Flush Back			
Options	3/4" Finished Paneled Back			
Interiors	Natural Birch Melamine	Unfinished particle board will absorb moisture and bubble.		
Options	Stained Matching Veneer			
Options	Natural Maple Veneer			
Shelves	3/4" thick Hardwood Plywood	Shelves that are only 5/8" thick are likely to bow.		
Base Shelves	Two-thirds depth, adjustable			
Options	Full depth, adjustable	Shelves that are not adjustable will limit how you can arrange the contents of your cabinets.		
Wall Shelves	Full depth, adjustable			
This is the best drawer in the industry! This is the best roll tray in the industry!		Some cabinetmakers cut costs by building their drawers with particle board or soft wood. They pin the drawer sides to the front and back. A drawer made with these materials and the pinning method WILL NOT stand up to the daily abuse kitchens drawers are put through. Insist on rugged material and dovetail joinery. Some cabinetmakers cut costs by not protecting the glides from the finish process, so the glides are speckled with the cabinet color.		
Drawers	4-sided box, 5/8" hardwood, dovetail joinery			
Options	Walnut drawer box			
Roll Trays	4-sided box, 5/8" hardwood, dovetail joinery			
Options	Walnut roll tray			
Glides	Full extension (you can reach everything in the drawer) Undermount (they are concealed, they won't collect debris, and the drawer box can be wider) Soft close (no more chipped dishes) is STANDARD			
Hinges	Six-way adjustable Soft close is STANDARD	Cabinetry will shrink and expand with the changing seasons. If you can't adjust your hinges to accommodate seasonal changes, your doors won't close properly. Soft close doors close themselves quietly. Combined with soft close glides on drawers, it reduces the noise in a kitchen, where most household action takes place.		

* **Why would you want flush ends?** When the side of the cabinet is visible, designers specify "flush" for a smooth finished appearance. Flush ends also make it easy to correctly install moulding.
How are flush ends created? Fieldstone Cabinetry builds flush ends by manufacturing the side panel to be flush with the face frame. Some cabinetmakers don't have the skill to create smooth joinery between the face frame and the end panel.

Third, service and support matter too.

THE MOST IMPORTANT THING TO KNOW.

Will the cabinetmaker deliver on time?

Floors, appliances and counter tops have to be coordinated with the delivery of cabinets. A delay will throw off several components of your project.

Fieldstone Cabinetry delivers 99% on time and complete.

We have a four to six week delivery time for overlay cabinetry and a six to eight week delivery time for inset cabinetry.



Ask these questions before you buy.

	FIELDSTONE[®] C A B I N E T R Y	Shop A	Shop B
Does the cabinetmaker have a written, firm delivery time? Floors, appliances and counter tops have to be coordinated with the delivery of cabinets. A delay will throw off several components of your project.	Fieldstone Cabinetry delivers 99% on time and complete. We have a four to six week delivery time for overlay cabinetry and a six to eight week delivery time for inset cabinetry.	<input type="checkbox"/>	<input type="checkbox"/>
Most projects need replacement parts and add-ons. Is there a timely process for obtaining these?	Fieldstone Cabinetry emphasizes fast turnaround on job completion items.	<input type="checkbox"/>	<input type="checkbox"/>
What is the warranty?	Fieldstone Cabinetry has a limited Lifetime Warranty.	<input type="checkbox"/>	<input type="checkbox"/>
Do you have to register to obtain the warranty?	Fieldstone Cabinetry's warranty is valid without registration.	<input type="checkbox"/>	<input type="checkbox"/>
Cabinetmakers often state that they have a lifetime warranty, but will they still be in business when you need them?	Fieldstone Cabinetry has been in business for over 45 years.	<input type="checkbox"/>	<input type="checkbox"/>

All Fieldstone Cabinetry finishes, material and construction are guaranteed by a limited Lifetime Warranty.

You didn't want a tunnel in your kitchen. Why do you have one?

Instead of building three or four or five cabinets to fit a given width, some cabinetmakers make one very long cabinet to save money. On the outside, it will kind of look like what you were expecting, but inside, it's not what you wanted.

Ask your cabinetmaker:

1. Will your cabinets be built to a layout that you approve?
2. Does this layout indicate the size and design of each cabinet?

Fieldstone Cabinetry dealers are educated professionals who can provide a detailed layout of your new kitchen. You'll know where the pull out waste bin is going to be, you'll know how wide each cabinet will be, you'll know which cabinets will receive roll out trays.

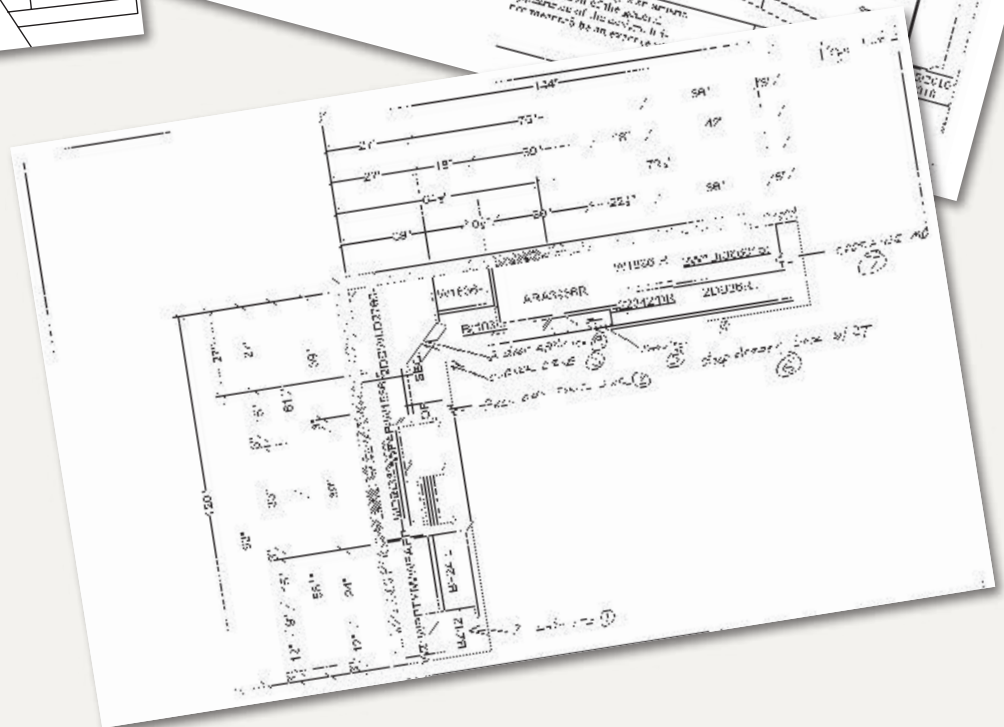
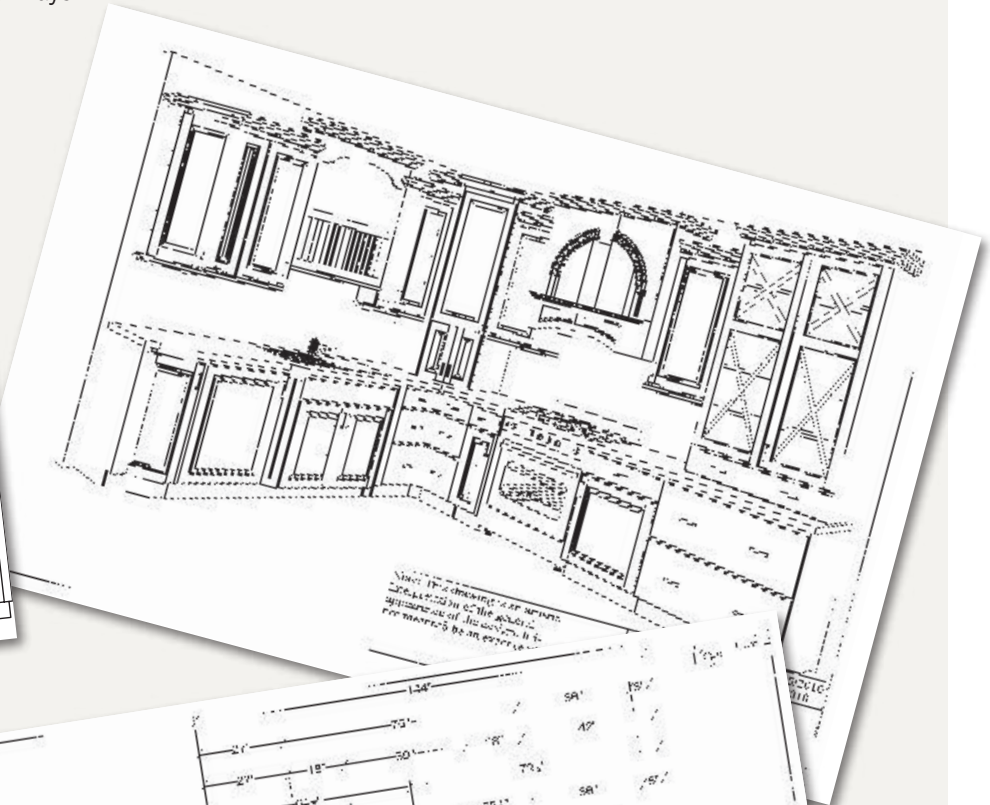
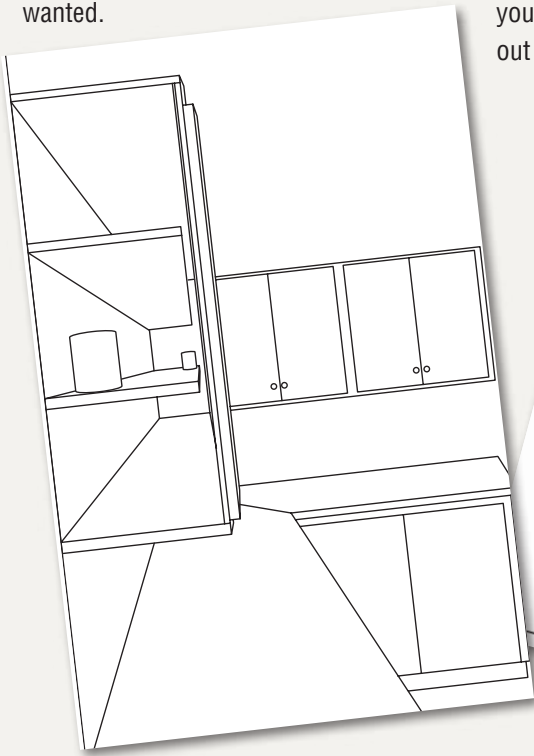

LEARN MORE

Review Fieldstone Cabinetry's warranty on our website fieldstonecabinetry.com.

Inset cabinets need special attention.

YOU NEED TO KNOW THIS ABOUT INSET.

Inset cabinetry is a style of cabinetry where the door is “set into” the face frame, instead of overlaying the face frame.

Overlay



Inset



- Inset cabinetry should be manufactured with tight tolerances between each door and the face frame, and between each drawer and the face frame. Large gaps are unattractive.
- Because of these tight tolerances:
 - If inset cabinets are not installed properly, doors and drawers may appear warped even when they are not.
 - You will need to adjust the doors and drawers each season as the temperatures change.
- Every homeowner should expect their walls and floors to have variations; a well-qualified installer can properly shim inset cabinetry so it does not become out of square.
- Ask about the standard depth of an inset cabinet. Most times, an inset wall cabinet will not accommodate oversized plates or oversized dinnerware. If you want to store oversized plates and dinnerware in an inset wall cabinet, the depth of the cabinet will need to be modified, and you'll want to know the charge for that. Fieldstone Cabinetry offers an increased depth up to 15" at no charge on inset wall cabinetry.

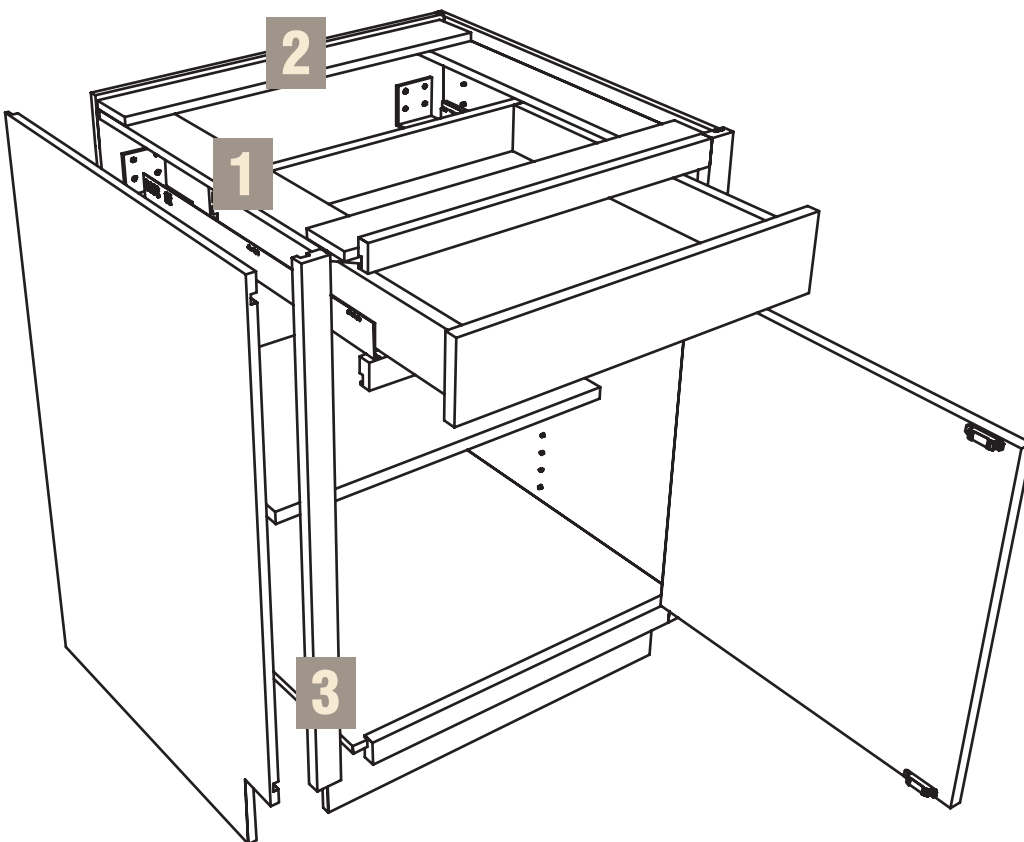

Fieldstone Cabinetry takes great care to create square, true inset cabinets.

1. Support runners are 1/2" thick hardwood plywood veneer core that connect the face frame, end panels and cabinet back on base cabinets.
2. Horizontal supports are 1/2" thick hardwood plywood veneer core that provide extra support on base cabinets.
3. Face frames are 3/4" thick select solid hardwood. Rails and stiles are joined with concealed screws and glue. Rails and stiles are dadoed to receive end panels, tops and bottoms.

Know before you buy inset cabinets.

FIELDSTONE[®] C A B I N E T R Y		What to watch out for	Cabinetry from Shop A	Cabinetry from Shop B
Face Frames	Solid 3/4" thick hardwood joined with concealed screws and glue. The joints are dadoed, a durable, time tested woodworking method.	How are the face frames attached? Some cabinetmakers cut costs by just nailing on the face frame, instead of using durable, time tested woodwork joinery.		
End Panels	3/4" Veneer Core Hardwood Plywood–Unfinished	Particle board isn't very strong, and it doesn't take finish evenly. Some cabinetmakers create cabinet exteriors with a mix of wood and melamine components. Be aware that melamine doesn't age like the wood components will, and eventually your kitchen will be two different colors.		
Options	3/4" Veneer Core Hardwood Plywood–Finished			
Options	3/4" Veneer Core Hardwood Plywood–Finished Furniture End			
Options	3/4" Veneer Core Hardwood Plywood–Flush* & Finished			
Tops	1/2" Veneer Core Hardwood Plywood			
Bottoms	1/2" Veneer Core Hardwood Plywood			
Back Panels	Nominal 1/2" Hardwood Plywood	Some cabinetmakers cut costs by eliminating the back panel. When you open the cabinet door, you will see the wall.		
Options	3/4" Finished Paneled Back			
Interiors	Natural Birch Melamine	Unfinished particle board will absorb moisture and bubble.		
Options	Stained Matching Veneer			
Options	Natural Maple Veneer			
Shelves	3/4" thick Hardwood Plywood	Shelves that are only 5/8" thick are likely to bow.		
Base Shelves	Two-thirds depth, adjustable			
Options	Full depth, adjustable	Shelves that are not adjustable will limit how you can arrange the contents of your cabinets.		
Wall Shelves	Full depth, adjustable			
This is the best drawer in the industry! This is the best roll tray in the industry!		Some cabinetmakers cut costs by building their drawers with particle board or soft wood. They pin the drawer sides to the front and back. A drawer made with these materials and the pinning method WILL NOT stand up to the daily abuse kitchens drawers are put through. Insist on rugged material and dovetail joinery. Some cabinetmakers cut costs by not protecting the glides from the finish process, so the glides are speckled with the cabinet color.		
Drawers	4-sided box, 5/8" hardwood, dovetail joinery			
Options	Walnut drawer box			
Roll Trays	4-sided box, 5/8" hardwood, dovetail joinery			
Options	Walnut roll tray			
Glides	Full extension (you can reach everything in the drawer) Undermount (they are concealed, they won't collect debris, and the drawer box can be wider) Soft close (no more chipped dishes) is STANDARD			
Hinge Options	Full wrap finial hinge in five color choices Concealed hinge with soft close	Cabinetry will shrink and expand with the changing seasons. If you can't adjust your hinges to accommodate seasonal changes, your doors won't close properly.		

* **Why would you want flush ends?** When the side of the cabinet is visible, designers specify "flush" for a smooth finished appearance. Flush ends also make it easy to correctly install moulding. **How are flush ends created?** Fieldstone Cabinetry builds flush ends by manufacturing the side panel to be flush with the face frame. Some cabinetmakers don't have the skill to create smooth joinery between the face frame and the end panel.

All Fieldstone Cabinetry finishes, material and construction are guaranteed by a limited Lifetime Warranty.

FIELDSTONE[®]
C A B I N E T R Y

Ask these questions before you buy.

	FIELDSTONE[®] C A B I N E T R Y	Cabinetry from Shop A	Cabinetry from Shop B
What is the selection of colors?	Fieldstone Cabinetry has hundreds of colors in our regular palette, plus custom colors. Plus, for stain based colors, there are two sheens from which to choose.	☞	☞
What is the selection of wood types?	Fieldstone Cabinetry has nine wood types.	☞	☞
What is the selection of organization and storage accessories?	Fieldstone Cabinetry has hundreds of organizational accessories.	☞	☞
What is the selection of decorative embellishments?	Fieldstone Cabinetry has thousands of accents: corbels, moulding and more.	☞	☞

Fieldstone Cabinetry has more than 1,000,000 combinations of doors, wood types and colors.



Traditional



Ornate

85+ DOOR STYLES

TRADITIONAL
ORNATE
TRANSITIONAL
CONTEMPORARY
COTTAGE/FARMHOUSE
ARTS & CRAFTS/
SHAKER/MISSION

WOOD TYPES

ALDER
RUSTIC ALDER
CHERRY
HICKORY
RUSTIC HICKORY
MAPLE
RED OAK
QUARTER SAWN WHITE OAK
WALNUT



Transitional



Contemporary

COLORS AVAILABLE

FROM WHITE TO BLACK AND EVERYTHING IN BETWEEN, WE HAVE HUNDREDS OF COLORS.

VISIT OUR WEBSITE FIELDSTONECABINETRY.COM TO BROWSE BY COLOR FAMILY:

WHITE AND OFF WHITE
LIGHT BROWN
MEDIUM BROWN
DARK BROWN
GRAY
BLUE
GREEN
RED
YELLOW
BLACK



Cottage/Farmhouse



Arts & Crafts/Shaker/Mission

Will you get what you want?

Fieldstone Cabinetry has hundreds of organizational accessories.



Fieldstone Cabinetry has thousands of accents: posts, corbels, moulding and more.



All Fieldstone Cabinetry finishes, material and construction are guaranteed by a limited Lifetime Warranty.

FIELDSTONE[®]
CABINETRY



American Craftsmanship
Manufactured in Sioux Falls, South Dakota
from domestic and global components.